



Electrolux



electrolux.com/register



EN User Manual | **Hob**

LRR8436



Welcome to Electrolux! Thank you for choosing our appliance.



Get usage advice, brochures, trouble shooter, service and repair information:
www.electrolux.com/support

Subject to change without notice.

CONTENTS

| | |
|---------------------------------|----|
| 1. SAFETY INFORMATION..... | 2 |
| 2. SAFETY INSTRUCTIONS..... | 4 |
| 3. INSTALLATION..... | 6 |
| 4. PRODUCT DESCRIPTION..... | 8 |
| 5. DAILY USE..... | 9 |
| 6. HINTS AND TIPS..... | 11 |
| 7. CARE AND CLEANING..... | 12 |
| 8. TROUBLESHOOTING..... | 13 |
| 9. TECHNICAL DATA..... | 14 |
| 10. ENERGY EFFICIENCY..... | 15 |
| 11. ENVIRONMENTAL CONCERNS..... | 16 |

1. ⚠ SAFETY INFORMATION

Before the installation and use of the appliance, carefully read the supplied instructions. The manufacturer is not responsible for any injuries or damage that are the result of incorrect installation or usage. Always keep the instructions in a safe and accessible location for future reference.

1.1 Children and vulnerable people safety

- This appliance can be used by children aged from 8 years and above and persons with reduced physical, sensory or mental capabilities or lack of experience and knowledge if they have been given supervision or instruction concerning the use of the appliance in a safe way and understand the hazards involved. Children of less than 8 years of age and persons with very extensive and complex disabilities shall be kept away from the appliance unless continuously supervised.
- Children should be supervised to ensure that they do not play with the appliance.

- Keep all packaging away from children and dispose of it appropriately.
- **WARNING:** The appliance and its accessible parts become hot during use. Keep children and pets away from the appliance when in use and when cooling down.
- If the appliance has a child safety device, it should be activated.
- Children shall not carry out cleaning and user maintenance of the appliance without supervision.

1.2 General Safety

- This appliance is for cooking purposes only.
- This appliance is designed for single household domestic use in an indoor environment.
- This appliance may be used in offices, hotel guest rooms, bed & breakfast guest rooms, farm guest houses and other similar accommodation where such use does not exceed (average) domestic usage levels.
- **WARNING:** The appliance and its accessible parts become hot during use. Care should be taken to avoid touching heating elements.
- **WARNING:** Unattended cooking on a hob with fat or oil can be dangerous and may result in fire.
- Smoke is an indication of overheating. Never use water to extinguish the cooking fire. Switch off the appliance and cover flames with e.g. a fire blanket or lid.
- **WARNING:** The appliance must not be supplied through an external switching device, such as a timer, or connected to a circuit that is regularly switched on and off by a utility.
- **CAUTION:** The cooking process has to be supervised. A short term cooking process has to be supervised continuously.
- **WARNING:** Danger of fire: Do not store items on the cooking surfaces.

- Metallic objects such as knives, forks, spoons and lids should not be placed on the hob surface since they can get hot.
- Do not use the appliance before installing it in the built-in structure.
- Do not use a steam cleaner to clean the appliance.
- **WARNING:** If the surface is cracked, switch off the appliance to avoid the possibility of electric shock. In case the appliance is connected to the mains directly using junction box, remove the fuse to disconnect the appliance from power supply. In either case contact the Authorised Service Centre.
- If the supply cord is damaged, it must be replaced by the manufacturer, an authorized Service or similarly qualified persons in order to avoid a hazard.
- **WARNING:** Use only hob guards designed by the manufacturer of the cooking appliance or indicated by the manufacturer of the appliance in the instructions for use as suitable or hob guards incorporated in the appliance. The use of inappropriate guards can cause accidents.

2. SAFETY INSTRUCTIONS

2.1 Installation

 **WARNING!**

Only a qualified person must install this appliance.

 **WARNING!**

Risk of injury or damage to the appliance.

- Remove all the packaging.
- Do not install or use a damaged appliance.
- Follow the installation instructions supplied with the appliance.
- Keep the minimum distance from other appliances and units.
- Always take care when moving the appliance as it is heavy. Always use safety gloves and enclosed footwear.
- Seal the cut surfaces of the cabinet with a sealant to prevent moisture from causing swelling.
- Protect the bottom of the appliance from steam and moisture.
- Do not install the appliance next to a door or under a window. This prevents hot cookware from falling from the appliance when the door or the window is opened.
- If the appliance is installed above drawers make sure that the space, between the bottom of the appliance and the upper drawer is sufficient for air circulation.
- The bottom of the appliance can get hot. Make sure to install a separation panel made from plywood, kitchen carcass material or other non-flammable materials under the appliance to prevent access to the bottom.

- The separation panel has to cover the area under the hob completely.

2.2 Electrical Connection

WARNING!

Risk of fire and electric shock.

- All electrical connections should be made by a qualified electrician.
- The appliance must be earthed.
- Before carrying out any operation make sure that the appliance is disconnected from the power supply.
- Make sure that the parameters on the rating plate are compatible with the electrical ratings of the mains power supply.
- Make sure the appliance is installed correctly. Loose and incorrect electricity mains cable or plug (if applicable) can make the terminal become too hot.
- Use the correct electricity mains cable.
- Do not let the electricity mains cable tangle.
- Make sure that a shock protection is installed.
- Use the strain relief clamp on the cable.
- Make sure the mains cable or plug (if applicable) does not touch the hot appliance or hot cookware, when you connect the appliance to a socket.
- Do not use multi-plug adapters and extension cables.
- Make sure not to cause damage to the mains plug (if applicable) or to the mains cable. Contact our Authorised Service Centre or an electrician to change a damaged mains cable.
- The shock protection of live and insulated parts must be fastened in such a way that it cannot be removed without tools.
- Connect the mains plug to the mains socket only at the end of the installation. Make sure that there is access to the mains plug after the installation.
- If the mains socket is loose, do not connect the mains plug.
- Do not pull the mains cable to disconnect the appliance. Always pull the mains plug.
- Use only correct isolation devices: line protecting cut-outs, fuses (screw type

fuses removed from the holder), earth leakage trips and contactors.

- The electrical installation must have an isolation device which lets you disconnect the appliance from the mains at all poles. The isolation device must have a contact opening width of minimum 3 mm.

2.3 Use

WARNING!

Risk of injury, burns and electric shock.

- Do not change the specification of this appliance.
- Remove all the packaging, labelling and protective film (if applicable) before first use.
- Make sure that the ventilation openings are not blocked.
- Do not let the appliance stay unattended during operation.
- Set the cooking zone to “off” after each use.
- Do not put cutlery or saucepan lids on the cooking zones. They can become hot.
- Do not operate the appliance with wet hands or when it has contact with water.
- Do not use the appliance as a work surface or as a storage surface.
- If the surface of the appliance is cracked, disconnect immediately the appliance from the power supply. This to prevent an electrical shock.
- When you place food into hot oil, it may splash.
- Do not use aluminum foil or other materials between the cooking surface and the cookware, unless otherwise specified by the manufacturer of this appliance.
- Use only accessories recommended for this appliance by the manufacturer.

WARNING!

Risk of fire and explosion.

- Fats and oil when heated can release flammable vapours. Keep flames or heated objects away from fats and oils when you cook with them.
- The vapours that very hot oil releases can cause spontaneous combustion.

- Used oil, that can contain food remnants, can cause fire at a lower temperature than oil used for the first time.
- Do not put flammable products or items that are wet with flammable products in, near or on the appliance.

⚠ WARNING!

Risk of damage to the appliance.

- Do not keep hot cookware on the control panel.
- Do not put a hot pan cover on the glass surface of the hob.
- Do not let cookware boil dry.
- Be careful not to let objects or cookware fall on the appliance. The surface can be damaged.
- Do not activate the cooking zones with empty cookware or without cookware.
- Cookware made of cast iron, aluminium or with a damaged bottom can cause scratches on the glass / glass ceramic. Always lift these objects up when you have to move them on the cooking surface.

2.4 Care and cleaning

- Clean the appliance regularly to prevent the deterioration of the surface material.
- Switch off the appliance and let it cool down before cleaning.
- Do not use water spray and steam to clean the appliance.

- Clean the appliance with a moist soft cloth. Use only neutral detergents. Do not use abrasive products, abrasive cleaning pads, solvents or metal objects, unless otherwise specified.

2.5 Service

- To repair the appliance contact the Authorised Service Centre. Use original spare parts only.
- Concerning the lamp(s) inside this product and spare part lamps sold separately: These lamps are intended to withstand extreme physical conditions in household appliances, such as temperature, vibration, humidity, or are intended to signal information about the operational status of the appliance. They are not intended to be used in other applications and are not suitable for household room illumination.

2.6 Disposal

⚠ WARNING!

Risk of injury or suffocation.

- Contact your local authority for information on how to dispose of the appliance.
- Disconnect the appliance from the mains supply.
- Cut off the mains electrical cable close to the appliance and dispose of it.

3. INSTALLATION

⚠ WARNING!

Refer to Safety chapters.

3.1 Before the installation

Before you install the hob, write down the information below from the rating plate. The rating plate is on the bottom of the hob.

Serial number

3.2 Built-in hobs

Only use the built-in hobs after you assemble the hob into correct built-in units and work surfaces that align to the standards.

3.3 Connection cable

- For a single phase or two phase connection, use the cable type: H03V2V2-F or H05BB-F which withstands a temperature of 90 °C or higher.
- To replace the damaged mains cable, use the cable: H03V2V2-F or H05BB-F which withstands a temperature of 90 °C or higher. Contact an Authorised Service

Centre. The connection cable may only be replaced by a qualified electrician.

3.4 Assembly

If you install the hob under a hood, please see the installation instructions of the hood for the minimum distance between the appliances.

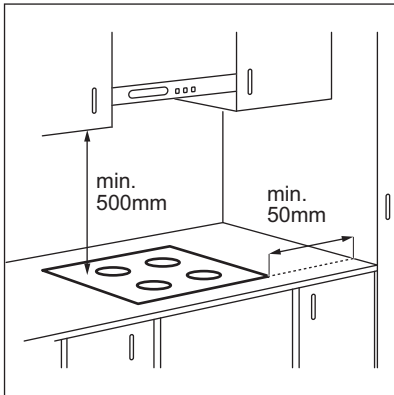

Combination with standard oven

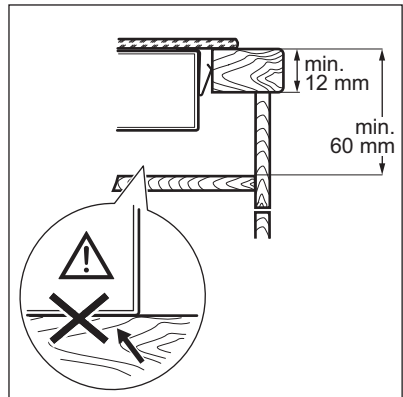
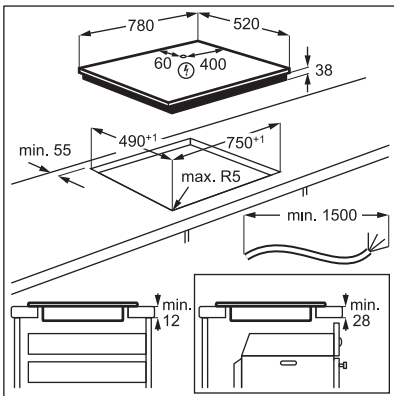

Combination with double oven

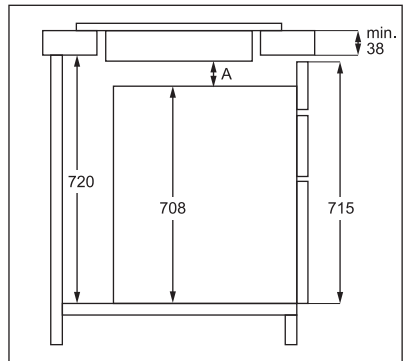

A = min. 6 mm, for double ovens from AEG, Electrolux and Zanussi.

A = min. 12 mm, for double ovens from other brands.

Find the video tutorial "How to install your Electrolux Radiant Hob - Worktop installation" by typing out the full name indicated in the graphic below.

 www.youtube.com/electrolux
www.youtube.com/aeg

How to install your Electrolux Radiant Hob - Worktop installation 

3.5 Protection box

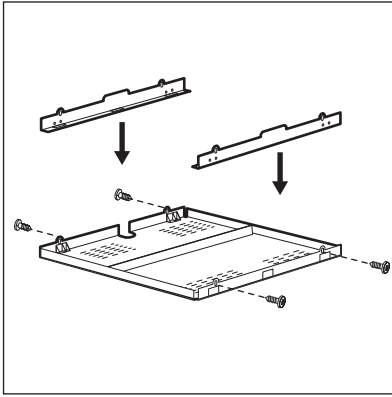

If you use a protection box (an additional accessory), the protective floor directly below the hob is not necessary. The protection box accessory may not be available in some countries. Contact Customer Support Service.



You cannot use the protection box if you install the hob above an oven.

4. PRODUCT DESCRIPTION

4.1 Cooking surface layout

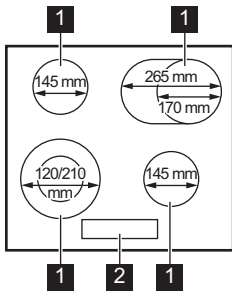



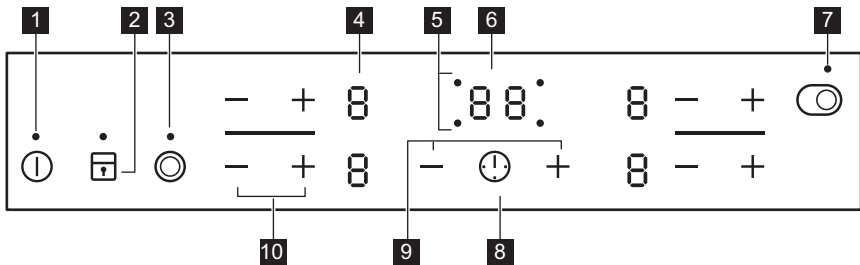

- 1** Cooking zone
- 2** Control panel







4.2 Control panel layout



Use the sensor fields to operate the appliance. The displays, indicators and sounds tell which functions operate.

| Sensor field | Function | Comment |
|---|-----------------------------------|--|
| 1  | On / Off | To activate and deactivate the hob. |
| 2  | Lock / Child Safety Device | To lock / unlock the control panel. |
| 3  | - | To activate and deactivate the outer ring. |
| 4 - | Heat setting display | To show the heat setting. |
| 5 - | Timer indicators of cooking zones | To show for which zone you set the time. |
| 6 - | Timer display | To show the time in minutes. |
| 7  | - | To activate and deactivate the outer ring. |
| 8  | - | To select the cooking zone. |
| 9 + / - | - | To increase or decrease the time. |
| 10 + / - | - | To set a heat setting. |

4.3 Heat setting displays

| Display | Description |
|--|--|
|  | The cooking zone is deactivated. |
|  | The cooking zone operates. |
|  | Automatic Heat Up operates. |
|  | There is a malfunction. |
|  | A cooking zone is still hot (residual heat). |
|  | Lock / Child Safety Device operates. |
|  | Automatic Switch Off operates. |

5. DAILY USE

WARNING!

Refer to Safety chapters.

5.1 Activating and deactivating

Touch  for 1 second to activate or deactivate the hob.

5.2 Automatic Switch Off





The function deactivates the hob automatically if:

- all cooking zones are deactivated,
- you do not set the heat setting after you activate the hob,

- you spill something or put something on the control panel for more than 10 seconds (a pan, a cloth, etc.). An acoustic signal sounds and the hob deactivates. Remove the object or clean the control panel.
- you do not deactivate a cooking zone or change the heat setting. After some time  comes on and the hob deactivates.

The relation between the heat setting and the time after which the hob deactivates:

5.3 The heat setting

Touch  to increase the heat setting. Touch  to decrease the heat setting. Touch  and  at the same time to deactivate the cooking zone.

5.4 Residual heat indicator

WARNING!

 As long as the indicator is visible, there is a risk of burns from residual heat.

The indicator  appears when a cooking zone is hot.



The indicator may also appear:

- for the neighbouring cooking zones even if you are not using them,
- when hot cookware is placed on cold cooking zone,
- when the hob is deactivated but the cooking zone is still hot.

The indicator disappears when the cooking zone has cooled down.

5.5 Activating and deactivating the outer rings

You can manually adjust the cooking surface to the dimensions of the cookware.

Set a heat setting for the cooking zone. Choose the symbol dedicated to the cooking zone:  .

To activate the outer ring: touch the symbol. The indicator appears.



To deactivate the outer ring: touch the symbol until the indicator disappears.

5.6 Automatic Heat Up

If you activate this function you can get a necessary heat setting in a shorter time. The function sets the highest heat setting for some time and then decreases to the correct heat setting.



To activate the function the cooking zone must be cold.

To activate the function for a cooking zone: touch  until the correct heat setting comes on. After 3 seconds  comes on.

To deactivate the function: touch .



5.7 Timer

• Count Down Timer



You can use this function to set the length of a single cooking session.

First set the heat setting for the cooking zone, then set the function.

To set the cooking zone: touch  repeatedly until the indicator of a cooking zone appears.

To activate the function or change the time: touch  or  of the timer to set the time (00 - 99 minutes). When the indicator of the cooking zone starts to flash, the time counts down.

To see the remaining time: touch  to set the cooking zone. The indicator of the cooking zone starts to flash. The display shows the remaining time.

To deactivate the function: touch  to set the cooking zone and then touch . The remaining time counts down to **00**. The indicator of the cooking zone disappears.





When the countdown ends, an acoustic signal sounds and **00** flashes. The cooking zone deactivates.



To stop the sound: touch .

• Minute Minder

You can use this function when the hob is activated and the cooking zones do not operate. The heat setting display shows .

To activate the function: touch  and then touch  or  of the timer to set the time. When the time finishes, an acoustic signal sounds and **00** flashes.

To stop the sound: touch .

To deactivate the function: touch  and then touch . The remaining time counts down to **00**.





The function has no effect on the operation of the cooking zones.

5.8 Lock

You can lock the control panel while cooking zones operate. It prevents an accidental change of the heat setting.

Set the heat setting first.

To activate the function: touch   comes on for 4 seconds. The Timer stays on.





To deactivate the function: touch . The previous heat setting comes on.











When you deactivate the hob, you also deactivate this function.

5.9 Child Safety Device

This function prevents an accidental operation of the hob.

To activate the function: activate the hob with . Do not set any heat setting. Touch  for 4 seconds.  comes on. Deactivate the hob with .

To deactivate the function: activate the hob with . Do not set any heat setting. Touch  for 4 seconds.  comes on. Deactivate the hob with .

To override the function for only one cooking time: activate the hob with .  comes on. Touch  for 4 seconds. **Set the heat setting in 10 seconds.** You can operate the hob. When you deactivate the hob with  the function operates again.

6. HINTS AND TIPS



WARNING!

Refer to Safety chapters.

6.1 Cookware

- To prevent overheating and improve the performance of the zones, the cookware must be as thick and flat as possible.
- Ensure cookware bases are clean and dry before placing on the hob surface.
- Always be careful no to slide or rub the cookware on the edges and corners of the glass as it may chip or damage the glass surface.



Cookware made of enamelled steel and with aluminium or copper bottoms can cause a colour change on the glass-ceramic surface.

6.2 Simplified cooking guide



The data in the table is for guidance only.

| Heat setting | Use to: | Time (min) | Hints |
|--------------|--|--------------|--|
| 1 | Keep cooked food warm. | as necessary | Put a lid on the cookware. |
| 1 - 2 | Hollandaise sauce; melt: butter, chocolate, gelatine. | 5 - 25 | Mix from time to time. |
| 2 | Solidify: fluffy omelettes, baked eggs. | 10 - 40 | Cook with a lid on. |
| 2 - 3 | Simmer rice and milk-based dishes, heat up ready-cooked meals. | 25 - 50 | Add at least twice as much liquid as rice, mix milk dishes halfway through the procedure. |
| 3 - 4 | Stew vegetables, fish, meat. | 20 - 45 | Add a few tablespoons of water. Check the water amount during the process. |
| 4 - 5 | Steam potatoes and other vegetables. | 20 - 60 | Cover the bottom of the pot with 1-2 cm of water. Check the water level during the process. Keep the lid on the pot. |
| 4 - 5 | Cook larger quantities of food, stews and soups. | 60 - 150 | Up to 3 l of liquid plus ingredients. |
| 6 - 7 | Gentle fry: escalope, veal cordon bleu, cutlets, rissoles, sausages, liver, roux, eggs, pancakes, doughnuts. | as necessary | Turn over when needed. |
| 7 - 8 | Heavy fry, hash browns, loin steaks, steaks. | 5 - 15 | Turn over when needed. |
| 9 | Boil water, cook pasta, sear meat (goulash, pot roast), deep-fry chips. | | |

7. CARE AND CLEANING

WARNING!

Refer to Safety chapters.

7.1 General information

- Clean the hob after each use.
- Always use cookware with a clean base.
- Scratches or dark stains on the surface have no effect on how the hob operates.
- Use a special cleaning agent suitable for the surface of the hob.
- Always use a scraper recommended for hobs with a glass surface. Use the scraper only as an additional tool for cleaning the glass after the standard cleaning procedure.

WARNING!

Do not use knives or any other sharp, metal tools to clean the glass surface.

7.2 Cleaning the hob

- **Remove immediately:** melted plastic, plastic foil, salt, sugar and food with sugar, otherwise, the dirt can cause damage to the hob. Take care to avoid burns. Use a special hob scraper on the glass surface at an acute angle and move the blade on the surface.
- **Remove when the hob is sufficiently cool:** limescale rings, water rings, fat stains, shiny metallic discoloration. Clean the hob with a moist cloth and a non-abrasive detergent. After cleaning, wipe the hob dry with a soft cloth.



- **Remove shiny metallic discoloration:**
use a solution of water with vinegar and clean the glass surface with a cloth.

8. TROUBLESHOOTING

WARNING!

Refer to Safety chapters.

8.1 What to do if...

| Problem | Possible cause | Remedy |
|---|---|---|
| You cannot activate or operate the hob. | The hob is not connected to an electrical supply or it is connected incorrectly. | Check if the hob is correctly connected to the electrical supply. |
| | The fuse is blown. | Make sure that the fuse is the cause of the malfunction. If the fuse is blown again and again, contact a qualified electrician. |
| | You did not set the heat setting for 10 seconds. | Activate the hob again and set the heat setting in less than 10 seconds. |
| | You touched 2 or more sensor fields at the same time. | Touch only one sensor field. |
| You can hear a constant beep noise. | There is water or fat stains on the control panel. | Clean the control panel. |
| | The electrical connection is incorrect. | Disconnect the hob from the electrical supply. Ask a qualified electrician to check the installation. |
| | You put something on one or more sensor fields. | Remove the object from the sensor fields. |
| An acoustic signal sounds and the hob deactivates. An acoustic signal sounds when the hob is deactivated. | You put something on the sensor field  . | Remove the object from the sensor field. |
| The hob deactivates. | You put something on the sensor field  . | Remove the object from the sensor field. |
| Residual heat indicator does not come on. | The zone is not hot because it operated only for a short time or the sensor is damaged. | If the zone operated sufficiently long to be hot, speak to an Authorised Service Centre. |
| Automatic Heat Up does not operate. | The highest heat setting is set. | The highest heat setting has the same power as the function. |
| | The zone is hot. | Let the zone become sufficiently cool. |
| | You decreased the heat setting to 0. | Start from 0 and increase the heat setting. |
|  There is a dark area on the multiple zone. | It is normal that there is a dark area on the multiple zone. | |

| Problem | Possible cause | Remedy |
|---|---|---|
| The control panel becomes hot to the touch. | The cookware is too large or you put it too close to the control panel. | Put large cookware on the rear zones, if possible. |
| L comes on. | Child Safety Device or Lock operates. | Refer to "Daily use". |
| E and a number come on. | There is an error in the hob. | Deactivate the hob and activate it again after 30 seconds. If E comes on again, disconnect the hob from the electrical supply. After 30 seconds, connect the hob again. If the problem continues, speak to an Authorised Service Centre. |
| EE comes on. | The second phase of the power supply is missing. | Check if the hob is correctly connected to the electrical supply. Remove the fuse, wait one minute, and insert the fuse again. |

8.2 If you cannot find a solution...

If you cannot find a solution to the problem yourself, contact your dealer or an Authorised Service Centre. Give the data from the rating plate. Give also three digit letter code for the glass ceramic (it is in the corner of the glass surface) and an error message that comes

on. Make sure, you operated the hob correctly. If not the servicing by a service technician or dealer will not be free of charge, also during the warranty period. The information about guarantee period and Authorised Service Centres are in the guarantee booklet.

9. TECHNICAL DATA

9.1 Rating plate

Model LRR8436
Typ 60 HBD 47 AO

Ser.Nr.
ELECTROLUX

PNC 949 599 351 00
220 - 240 V / 400 V 2N, 50 - 60 Hz
Made in: Germany
7.0 kW



9.2 Cooking zones specification

| Cooking zone | Nominal Power (Max heat setting) [W] | Cooking zone diameter [mm] |
|--------------|--------------------------------------|----------------------------|
| Left front | 750 / 2200 | 120 / 210 |
| Left rear | 1200 | 145 |
| Right front | 1200 | 145 |
| Right rear | 1500 / 2400 | 170 / 265 |

For optimal cooking results use cookware no larger than the diameter of the cooking zone.

10. ENERGY EFFICIENCY

10.1 Product Information according to EU and UK Ecodesign Regulations

| | | |
|---|--|--|
| Model identification | LRR8436 | |
| Type of hob | Built-In Hob | |
| Number of cooking zones | 4 | |
| Heating technology | Radiant Heater | |
| Diameter of circular cooking zones (Ø) | Left front Left rear Right front | 21.0 cm 14.5 cm 14.5 cm |
| Length (L) and width (W) of non circular cooking zone | Right rear | L 26.5 cm W 17.0 cm |
| Energy consumption per cooking zone (EC electric cooking) | Left front Left rear Right front Right rear | 200.1 Wh/kg 188.0 Wh/kg 188.0 Wh/kg 191.6 Wh/kg |
| Energy consumption of the hob (EC electric hob) | 191.9 Wh/kg | |

IEC / EN 60350-2, BS EN 60350-2 - Household electric cooking appliances - Part 2: Hobs - Methods for measuring performance.

10.2 Energy saving

You can save energy during everyday cooking if you follow the hints below.

- When you heat up water, use only the amount you need.
- If it is possible, always put the lids on the cookware.

- Before you activate the cooking zone put the cookware on it.
- The cookware bottom should have the same diameter as the cooking zone.
- Put the smaller cookware on the smaller cooking zones.
- Put the cookware directly in the centre of the cooking zone.
- Use the residual heat to keep the food warm or to melt it.

10.3 Product Information for power consumption and maximum time to reach applicable low power mode

| | |
|--|-------|
| Power consumption in off mode | 0.3 W |
| Maximum time needed for the equipment to automatically reach the applicable low power mode | 2 min |

11. ENVIRONMENTAL CONCERNS

Recycle materials with the symbol . Put the packaging in relevant containers to recycle it. Help protect the environment and human health by recycling waste of electrical and electronic appliances. Do not dispose of

appliances marked with the symbol  with the household waste. Return the product to your local recycling facility or contact your municipal office.







electrolux.com

867384773-B-142024



**UK
CA** **CE**