

WE'RE THINKING OF YOU

Thank you for purchasing an Electrolux appliance. You've chosen a product that brings with it decades of professional experience and innovation. Ingenious and stylish, it has been designed with you in mind. So whenever you use it, you can be safe in the knowledge that you'll get great results every time.

Welcome to Electrolux.

Visit our website to:



Get usage advice, brochures, troubleshooting, service and repair information:
www.electrolux.com/support



Register your product for better service:
www.registerelectrolux.com



Buy Accessories, Consumables and Original spare parts for your appliance:
www.electrolux.com/shop

CUSTOMER CARE AND SERVICE

Always use original spare parts.

When contacting our Authorised Service Centre, ensure that you have the following data available: Model, PNC, Serial Number.

The information can be found on the rating plate.

Warning / Caution-Safety information

General information and tips

Environmental information

CONTENTS

1. SAFETY INFORMATION.....	3	4.3 Display.....	10
1.1 Children and vulnerable people safety.....	3	5. BEFORE FIRST USE.....	11
1.2 General Safety.....	4	5.1 Initial cleaning.....	11
2. SAFETY INSTRUCTIONS.....	5	5.2 Initial preheating.....	11
2.1 Installation.....	5	6. DAILY USE.....	11
2.2 Electrical connection.....	6	6.1 How to set: Heating functions.....	11
2.3 Use.....	6	6.2 Main oven functions.....	12
2.4 Care and cleaning.....	7	6.3 Top oven functions.....	13
2.5 Internal lighting.....	7	6.4 Notes on: Moist Fan Baking.....	13
2.6 Service.....	8	7. CLOCK FUNCTIONS.....	14
2.7 Disposal.....	8	7.1 Clock functions.....	14
3. PRODUCT DESCRIPTION.....	9	7.2 How to set: Clock functions.....	14
3.1 General overview.....	9	8. USING THE ACCESSORIES.....	16
3.2 Accessories.....	9	8.1 Inserting accessories.....	16
4. CONTROL PANEL.....	10	8.2 Using Trivet and Grill- / Roasting pan.....	16
4.1 Retractable knobs.....	10		
4.2 Control panel overview.....	10		

9. ADDITIONAL FUNCTIONS.....	17	11.4 How to remove and install: Door..	23
9.1 Lock.....	17	11.5 How to replace: Lamp.....	24
9.2 Automatic switch-off.....	18	12. TROUBLESHOOTING.....	25
9.3 Cooling fan.....	18	12.1 What to do if.....	25
10. HINTS AND TIPS.....	18	12.2 Service data.....	26
10.1 Cooking recommendations.....	18	13. ENERGY EFFICIENCY.....	26
10.2 Moist Fan Baking.....	18	13.1 Product Information and Product	
10.3 Moist Fan Baking -		Information Sheet.....	26
recommended accessories.....	20	13.2 Energy saving.....	27
10.4 Cooking tables for test institutes..	20	14. MENU STRUCTURE.....	27
11. CARE AND CLEANING.....	21	14.1 Menu.....	27
11.1 Notes on cleaning.....	21	15. ENVIRONMENTAL CONCERNS.....	28
11.2 How to remove: Shelf supports ...	22		
11.3 How to use: Catalytic cleaning	22		

Subject to change without notice.

1. ⚠ SAFETY INFORMATION

Before the installation and use of the appliance, carefully read the supplied instructions. The manufacturer is not responsible for any injuries or damage that are the result of incorrect installation or usage. Always keep the instructions in a safe and accessible location for future reference.

1.1 Children and vulnerable people safety

- This appliance can be used by children aged from 8 years and above and persons with reduced physical, sensory or mental capabilities or lack of experience and knowledge if they have been given supervision or instruction concerning the use of the appliance in a safe way and understand the hazards involved. Children of less than 8 years of age and persons with very extensive and complex disabilities shall be kept away from the appliance unless continuously supervised.
- Children should be supervised to ensure that they do not play with the appliance.
- Keep all packaging away from children and dispose of it appropriately.

SAFETY INFORMATION

- **WARNING:** The appliance and its accessible parts become hot during use. Keep children and pets away from the appliance when in use and when cooling down.
- If the appliance has a child safety device, it should be activated.
- Children shall not carry out cleaning and user maintenance of the appliance without supervision.

1.2 General Safety

- This appliance is for cooking purposes only.
- This appliance is designed for single household domestic use in an indoor environment.
- This appliance may be used in, offices, hotel guest rooms, bed & breakfast guest rooms, farm guest houses and other similar accommodation where such use does not exceed (average) domestic usage levels.
- Only a qualified person must install this appliance and replace the cable.
- Do not use the appliance before installing it in the built-in structure.
- Disconnect the appliance from the power supply before carrying out any maintenance.
- If the supply cord is damaged, it must be replaced by the manufacturer, its Authorised Service Centre or similarly qualified persons to avoid an electrical hazard.
- The means for disconnection must be incorporated in the fixed wiring in accordance with the wiring rules.
- **WARNING:** Ensure that the appliance is switched off before replacing the lamp to avoid the possibility of electric shock.
- **WARNING:** The appliance and its accessible parts become hot during use. Care should be taken to avoid touching heating elements or the surface of the appliance cavity.
- Always use oven gloves to remove or insert accessories or ovenware.

- To remove the shelf supports first pull the front of the shelf support and then the rear end away from the side walls. Install the shelf supports in the opposite sequence.
- Do not use a steam cleaner to clean the appliance.
- Do not use harsh abrasive cleaners or sharp metal scrapers to clean the glass door since they can scratch the surface, which may result in shattering of the glass.

2. SAFETY INSTRUCTIONS

2.1 Installation

**WARNING!**

Only a qualified person must install this appliance.

- Remove all the packaging.
- Do not install or use a damaged appliance.
- Follow the installation instructions supplied with the appliance.
- Always take care when moving the appliance as it is heavy. Always use safety gloves and enclosed footwear.
- Do not pull the appliance by the handle.
- Install the appliance in a safe and suitable place that meets installation requirements.
- Keep the minimum distance from other appliances and units.
- Before mounting the appliance, check if the appliance door opens without restraint.
- The appliance is equipped with an electric cooling system. It must be operated with the electric power supply.
- The built-in unit must meet the stability requirements of DIN 68930.

Cabinet minimum height (Cabinet under the work-top minimum height)	875 mm
Cabinet width	560-570 mm
Cabinet depth	550 mm
Height of the front of the appliance	888 mm
Height of the back of the appliance	872 mm
Width of the front of the appliance	594 mm
Width of the back of the appliance	538 mm
Depth of the appliance	568 mm

SAFETY INSTRUCTIONS

Built in depth of the appliance	547 mm
Depth with open door	858 mm
Ventilation opening minimum size. Opening placed on the bottom rear side	560x20 mm
Mounting screws	3.5x25 mm

2.2 Electrical connection



WARNING!

Risk of fire and electric shock.

- All electrical connections should be made by a qualified electrician.
- The appliance must be earthed.
- Make sure that the parameters on the rating plate are compatible with the electrical ratings of the mains power supply.
- Always use a correctly installed shockproof socket.
- Do not use multi-plug adapters and extension cables.
- Make sure not to cause damage to the mains plug and to the mains cable. Should the mains cable need to be replaced, this must be carried out by our Authorised Service Centre.
- Do not let mains cables touch or come near the appliance door or the niche below the appliance, especially when it operates or the door is hot.
- The shock protection of live and insulated parts must be fastened in such a way that it cannot be removed without tools.
- Connect the mains plug to the mains socket only at the end of the installation. Make sure that there is access to the mains plug after the installation.
- If the mains socket is loose, do not connect the mains plug.
- Do not pull the mains cable to disconnect the appliance. Always pull the mains plug.
- Use only correct isolation devices: line protecting cut-outs, fuses (screw type fuses removed from the holder), earth leakage trips and contactors.
- The electrical installation must have an isolation device which lets you disconnect the appliance from the mains at all poles. The isolation device must have a contact opening width of minimum 3 mm.
- This appliance is supplied without a main plug and a main cable.

2.3 Use



WARNING!

Risk of injury, burns and electric shock or explosion.

- Do not change the specification of this appliance.
- Make sure that the ventilation openings are not blocked.
- Do not let the appliance stay unattended during operation.
- Deactivate the appliance after each use.
- Be careful when you open the appliance door while the appliance is in operation. Hot air can release.

- Do not operate the appliance with wet hands or when it has contact with water.
- Do not apply pressure on the open door.
- Do not use the appliance as a work surface or as a storage surface.
- Open the appliance door carefully. The use of ingredients with alcohol can cause a mixture of alcohol and air.
- Do not let sparks or open flames to come in contact with the appliance when you open the door.
- Do not put flammable products or items that are wet with flammable products in, near or on the appliance.

**WARNING!**

Risk of damage to the appliance.

- To prevent damage or discoloration to the enamel:
 - do not put overware or other objects in the appliance directly on the bottom.
 - do not put aluminium foil directly on the bottom of cavity of the appliance.
 - do not put water directly into the hot appliance.
 - do not keep moist dishes and food in the appliance after you finish the cooking.
 - be careful when you remove or install the accessories.
- Discoloration of the enamel or stainless steel has no effect on the performance of the appliance.
- Use a deep pan for moist cakes. Fruit juices cause stains that can be permanent.
- Always cook with the appliance door closed.
- If the appliance is installed behind a furniture panel (e.g. a door) make sure the door is never closed when the appliance operates. Heat and moisture can build up behind a closed furniture panel and cause subsequent damage to the appliance, the housing unit or the floor. Do not close the furniture panel until the appliance has cooled down completely after use.

2.4 Care and cleaning

**WARNING!**

Risk of injury, fire, or damage to the appliance.

- Before maintenance, deactivate the appliance and disconnect the mains plug from the mains socket.
- Make sure the appliance is cold. There is the risk that the glass panels can break.
- Replace immediately the door glass panels when they are damaged. Contact the Authorised Service Centre.
- Be careful when you remove the door from the appliance. The door is heavy!
- Clean regularly the appliance to prevent the deterioration of the surface material.
- Clean the appliance with a moist soft cloth. Use only neutral detergents. Do not use abrasive products, abrasive cleaning pads, solvents or metal objects.
- If you use an oven spray, follow the safety instructions on its packaging.
- Do not clean the catalytic enamel with detergents.

2.5 Internal lighting

**WARNING!**

Risk of electric shock.

- Concerning the lamp(s) inside this product and spare part lamps sold separately: These lamps are intended to withstand extreme physical conditions in household appliances, such

SAFETY INSTRUCTIONS

as temperature, vibration, humidity, or are intended to signal information about the operational status of the appliance. They are not intended to be used in other applications and are not suitable for household room illumination.

- This product contains a light source of energy efficiency class G.
- Use only lamps with the same specifications.

2.6 Service

- To repair the appliance contact the Authorised Service Centre.
- Use original spare parts only.

2.7 Disposal



WARNING!

Risk of injury or suffocation.

- Contact your municipal authority for information on how to dispose of the appliance.
- Disconnect the appliance from the mains supply.
- Cut off the mains electrical cable close to the appliance and dispose of it.
- Remove the door catch to prevent children or pets from becoming trapped in the appliance.

3. PRODUCT DESCRIPTION

3.1 General overview

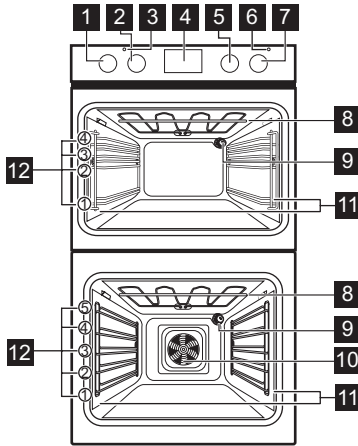

- 1** Knob for the top oven functions
- 2** Knob for the top oven temperature
- 3** Temperature indicator / symbol for the top oven
- 4** Display
- 5** Knob for the main oven functions
- 6** Temperature indicator / symbol for the main oven
- 7** Knob for the main oven temperature
- 8** Heating element
- 9** Lamp
- 10** Fan
- 11** Shelf support, removable
- 12** Shelf positions

3.2 Accessories

- **Wire shelf**
For cookware, cake tins, roasts.
- **Grill- / Roasting pan**
To bake and roast or as pan to collect fat.
- **Trivet**
For roasting and grilling.

i Use the trivet only with the Grill- / roasting pan.







CONTROL PANEL

4. CONTROL PANEL

4.1 Retractable knobs

To use the appliance press the knob. The knob comes out.







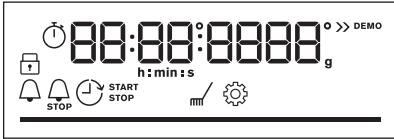

4.2 Control panel overview

				OK		
Timer	Fast Heat Up	Light	Lock	Confirm setting	Press	Turn the knob
Select a heating function to turn on the appliance.						
Turn the knob for the heating functions to the off position to turn the appliance off.						

4.3 Display

	Display with key functions.
--	-----------------------------

Display indicators

Basic indicators			
 Lock	 Cleaning	 Settings	 Fast Heat Up
Timer indicators			
 Minute minder	 End time	 Time Delay	 Uptimer
Progress bar - for temperature or time. The bar is fully red when the appliance reaches the set temperature.			

5. BEFORE FIRST USE



WARNING!

Refer to Safety chapters.

5.1 Initial cleaning

Before the first use, clean the empty appliance and set the time:







00:00

Set the time. Press OK.

5.2 Initial preheating

Preheat both ovens. Heat up one oven at a time. Set the functions listed below, if applicable.

Step 1	Remove all accessories and removable shelf supports from the oven.
Step 2	Set the function  and the temperature to 250°C. Let the oven operate for 1 h.
Step 3	Set the function  and the temperature to 250°C. Let the oven operate for 15 min.
Step 4	Set the function  and the temperature to 250°C. Let the oven operate for 15 min.

 The oven can emit an odour and smoke during preheating. Make sure that the room is ventilated.

6. DAILY USE



WARNING!









Refer to Safety chapters.



6.1 How to set: Heating functions

Step 1	Turn the knob for the heating functions and select a heating function.
---------------	--







Step 2	Turn the control knob to set the temperature. Press OK .
 - press and hold to turn on the function: Fast Heat Up. It is available for some oven functions.	

6.2 Main oven functions

Heating function	Application
 True Fan Cooking	To bake on up to two shelf positions at the same time and to dry food. Set the temperature 20 - 40 °C lower than for Conventional Cooking.
 Conventional Cooking	To bake and roast food on one shelf position.
 Frozen Foods	To make convenience food (e.g., french fries, potato wedges or spring rolls) crispy.
 Pizza Function	To bake pizza. To make intensive browning and a crispy bottom.
 Bottom Heat	To bake cakes with crispy bottom and to preserve food.
 Defrost	To defrost food (vegetables and fruit). The defrosting time depends on the amount and size of the frozen food.
 Moist Fan Baking	This function is designed to save energy during cooking. When you use this function, the temperature in the cavity may differ from the set temperature. The residual heat is used. The heating power may be reduced. For more information refer to "Daily Use" chapter, Notes on: Moist Fan Baking.
 Grill	To grill thin pieces of food and to toast bread.

Heating function	Application
 Turbo Grilling	To roast large meat joints or poultry with bones on one shelf position. To make gratins and to brown.
 Menu	To enter the Menu: Cleaning, Settings.

6.3 Top oven functions

Heating function	Application
 Light	To turn on the lamp.
 Conventional Cooking / Clean- ing	To bake and roast food on one shelf position. Refer to "Care and Cleaning" chapter for more information about Catalytic cleaning.
 Top Heat	To brown bread, cakes and pastries. To finish cooked dishes.
 Bottom Heat	To bake cakes with crispy bottom and to preserve food.
 Grill	To grill thin pieces of food and to toast bread.
 Fast Grilling	To grill thin pieces of food in large quantities and to toast bread.

6.4 Notes on: Moist Fan Baking

This function was used to comply with the energy efficiency class and ecodesign requirements (according to EU 65/2014 and EU 66/2014). Tests according to: IEC/EN 60350-1

CLOCK FUNCTIONS





The oven door should be closed during cooking so that the function is not interrupted and the oven operates with the highest energy efficiency possible.

When you use this function the lamp automatically turns off.



For the cooking instructions refer to "Hints and tips" chapter, Moist Fan Baking. For general energy saving recommendations refer to "Energy Efficiency" chapter, Energy Saving.







7. CLOCK FUNCTIONS









7.1 Clock functions













Clock Function	Application
 Minute minder	When the timer ends, the signal sounds.
 Cooking time	When the timer ends, the signal sounds and the heating function stops. The function works only for the main oven.
 Time Delay	To postpone the start and / or end of cooking. The function works only for the main oven.
 Uptimer	Maximum is 23 h 59 min. This function has no effect on the operation of the oven. To turn on and off the Uptimer select: Menu, Settings.

7.2 How to set: Clock functions

How to set: Time of day		
Step 1	Step 2	Step 3
		
To change the time of day enter the menu and select Settings, Time of day.	Set the clock.	Press: OK.

How to set: Minute minder			
Step 1	The display shows: 0:00 	Step 2	Step 3
			
Press: 		Set the Minute minder	Press: OK , 
 Timer starts counting down immediately.			

How to set: Cooking time				
Step 1	Step 2	The display shows: 0:00  STOP	Step 3	Step 4
				
Choose a heating function and set the temperature.	Press repeatedly: 		Set the cooking time.	Press: OK , 
 Timer starts counting down immediately.				

How to set: Time Delay							
Step 1	Step 2	The display shows: the time of day  START	Step 3	Step 4	The display shows: --:--  STOP	Step 5	Step 6
							
Select the heating function.	Press repeatedly: 		Set the start time.	Press: OK , 		Set the end time.	Press: OK , 
 Timer starts counting down at a set start time.							

8. USING THE ACCESSORIES



WARNING!

Refer to Safety chapters.

8.1 Inserting accessories

A small indentation at the top increases safety. The indentations are also anti-tip devices. The high rim around the shelf prevents cookware from slipping of the shelf.

Wire shelf:

Push the shelf between the guide bars of the shelf support.

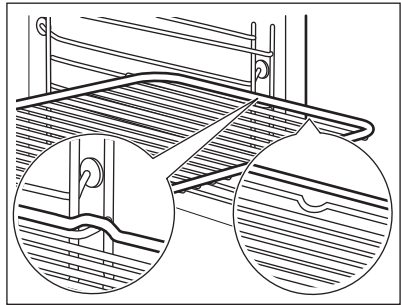

Deep pan:

Push the tray between the guide bars of the shelf support.

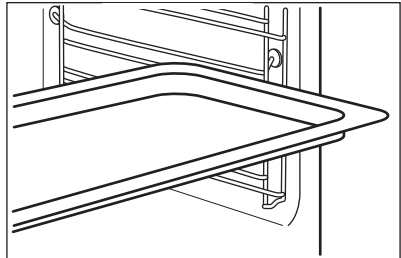

8.2 Using Trivet and Grill- / Roasting pan



WARNING!



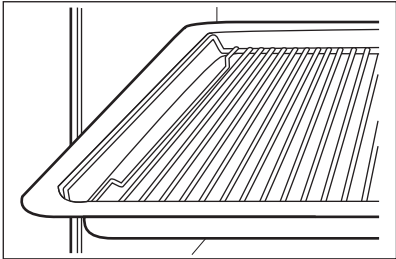
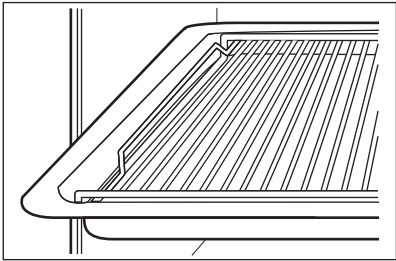

Be careful when you remove the accessories from a hot oven. There is a risk of burns.

You can use the trivet to roast larger pieces of meat or poultry on one shelf position.

<p>Step 1</p>	<p>Put the trivet into the deep pan so that the supports of the wire shelf point up.</p>	
<p>Step 2 Put the deep pan into the oven on the necessary shelf position.</p>		
<p>You can use the trivet to grill flat dishes in large quantities and to toast.</p>		
<p>Step 1</p>	<p>Put the trivet into the deep pan so that the supports of the wire shelf point down.</p>	
<p>Step 2 Put the deep pan into the oven on the necessary shelf position.</p>		

9. ADDITIONAL FUNCTIONS



9.1 Lock

<p>This function prevents an accidental change of the appliance function. It works only for the main oven.</p>		
<p>Turn it on when the appliance works - the set cooking continues, the control panel is locked. Turn it on when the appliance is off - it cannot be turned on, the control panel is locked.</p>		
	<p> - press and hold to turn on the function. A signal sounds.</p>	<p> - press and hold to turn it off.</p>
<p> 3 x  - flashes when the lock is turned on.</p>		

HINTS AND TIPS

9.2 Automatic switch-off

The function works only for the main oven. For safety reasons the appliance turns off after some time, if a heating function works and you do not change any settings.

 (°C)	 (h)
30 - 115	12.5
120 - 195	8.5
200 - 245	5.5
250 - maximum	3

The Automatic switch-off does not work with the functions: Light, Time Delay.

9.3 Cooling fan

When the appliance operates, the cooling fan turns on automatically to keep the surfaces of the appliance cool. If you turn off the appliance, the cooling fan can continue to operate until the appliance cools down.





10. HINTS AND TIPS

10.1 Cooking recommendations







<p>The temperature and cooking times in the tables are guidelines only. They depend on the recipes and the quality and quantity of the ingredients used. Your appliance may bake or roast differently to the appliance you had before. The hints below show recommended settings for temperature, cooking time and shelf position for specific types of the food. If you cannot find the settings for a special recipe, look for the similar one.</p>

10.2 Moist Fan Baking

For the best results follow suggestions listed in the table below.

		 (°C)		 (min)
Sweet rolls, 16 pieces	baking tray or dripping pan	180	3	35 - 45





HINTS AND TIPS

		 (°C)		 (min)
Swiss Roll	baking tray or dripping pan	180	2	30 - 40
Brownie	baking tray or dripping pan	180	2	30 - 40
Sponge flan base	flan base tin on wire shelf	180	2	30 - 40
Victoria sandwich	baking dish on wire shelf	170	2	40 - 50
Poached fish, 0.3 kg	baking tray or dripping pan	180	3	20 - 30
Whole fish, 0.2 kg	baking tray or dripping pan	180	3	20 - 30
Poached meat, 0.25 kg	baking tray or dripping pan	200	3	30 - 40
Cookies, 16 pieces	baking tray or dripping pan	170	2	25 - 35
Macaroons, 24 pieces	baking tray or dripping pan	160	2	35 - 45
Muffins, 12 pieces	baking tray or dripping pan	170	2	25 - 35
Savory pastry, 20 pieces	baking tray or dripping pan	170	3	30 - 40
Short crust biscuits, 20 pieces	baking tray or dripping pan	150	3	30 - 40
Tartlets, 8 pieces	baking tray or dripping pan	180	2	25 - 35
Vegetables, poached, 0.4 kg	baking tray or dripping pan	180	3	30 - 40
Vegetarian omelette	pizza pan on wire shelf	200	3	35 - 45

HINTS AND TIPS

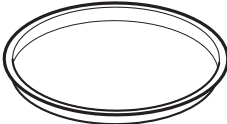
10.3 Moist Fan Baking - recommended accessories







Use the dark and non-reflective tins and containers. They have better heat absorption than the light colour and reflective dishes.







			
Pizza pan	Baking dish	Ramekins	Flan base tin
Dark, non-reflective 28 cm diameter	Dark, non-reflective 26 cm diameter	Ceramic 8 cm diameter, 5 cm height	Dark, non-reflective 28 cm diameter

10.4 Cooking tables for test institutes

Information for test institutes

Tests according to: EN 60350-1, IEC 60350-1. Tests must be performed in the main oven.

				 (°C)	 (min)	
Small cakes	Conventional Cooking	Baking tray	2	160	20 - 30	Preheat the oven
Small cakes	True Fan Cooking	Baking tray	2	150	20 - 30	Preheat the oven
Apple pie	Conventional Cooking	Baking tray	1	170	55 - 70	-
Apple pie	True Fan Cooking	Baking tray	2	160	60 - 75	-
Fatless sponge cake	Conventional Cooking	Wire shelf	2	160 - 170	50 - 60	-
Fatless sponge cake	True Fan Cooking	Wire shelf	2	150 - 160	50 - 60	-

				 (°C)	 (min)	
Short bread	Conventional Cooking	Baking tray	2	160 - 170	30 - 35	-
Short bread	True Fan Cooking	Baking tray	2	140	20 - 30	-
Toast	Grill	Wire shelf	4	230	1	Preheat the oven for 5 min



11. CARE AND CLEANING



WARNING!

Refer to Safety chapters.

11.1 Notes on cleaning

 Cleaning Agents	Clean the front of the appliance only with a microfibre cloth with warm water and a mild detergent.
	Use a cleaning solution to clean metal surfaces.
	Clean stains with a mild detergent. Do not apply it on the catalytic surfaces.
 Everyday Use	Clean the cavity after each use. Fat accumulation or other residue may cause fire.
	Do not store the food in the appliance for longer than 20 minutes. Dry the cavity only with a microfibre cloth after each use.
 Accessories	Clean all accessories after each use and let them dry. Use only a microfibre cloth with warm water and a mild detergent. Do not clean the accessories in a dishwasher.
	Do not clean the non-stick accessories using abrasive cleaner or sharp-edged objects.

CARE AND CLEANING

11.2 How to remove: Shelf supports

Remove the shelf supports to clean the oven.

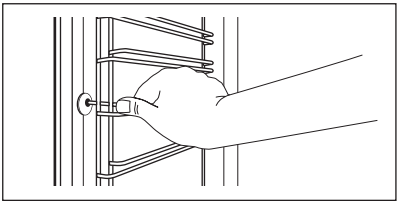
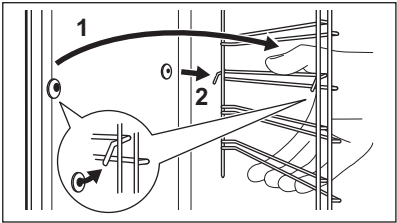
Step 1	Turn off the oven and wait until it is cold.	
Step 2	Pull the front of the shelf support away from the side wall.	
Step 3	Pull the rear end of the shelf support away from the side wall and remove it.	
Step 4	Install the shelf supports in the opposite sequence.	



11.3 How to use: Catalytic cleaning

The cavity is coated with catalytic enamel. It absorbs fat during catalysis. The catalytic enamel is self cleaning, do not clean it with a cloth.

Spots or discolouration of the catalytic coating have no effect on the cleaning.

Clean one oven at a time.

Before the catalytic cleaning		
Turn off the oven and wait until it is cold.	Remove all accessories and removable shelf supports.	Clean the oven floor and the inner door glass with warm water, soft cloth and mild detergent.

Clean the main oven with catalytic cleaning		
Step 1	Step 2	Step 3
Select Menu  / Cleaning  and press OK . Duration: 1 h	When the cleaning ends the signal sounds. The oven turns off.	When the oven is cold, clean the oven floor with a wet soft cloth

Clean the top oven with catalytic cleaning

Step 1	Step 2	Step 3	Step 4
To clean the top oven set the function:  .	Set the maximum oven temperature. Duration: 1 h	After cleaning, turn the knob for the oven functions to the off position.	When the oven is cold, clean the oven floor with a wet soft cloth

11.4 How to remove and install: Door

You can remove the door and the internal glass panels to clean it. The number of glass panels is different for different models.



WARNING!

The door is heavy.



CAUTION!

Carefully handle the glass, especially around the edges of the front panel. The glass can break.

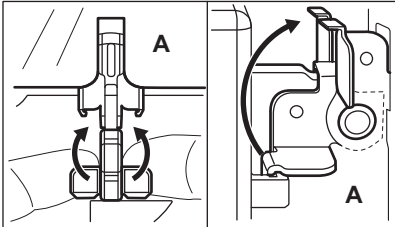
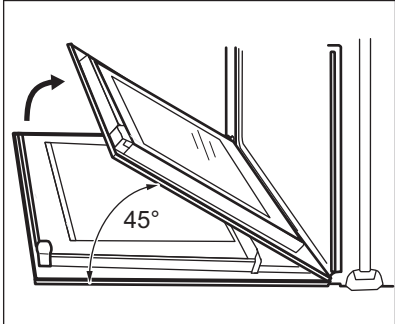
Step 1	Fully open the door.	
Step 2	Lift and press the clamping levers (A) on the two door hinges.	
Step 3	Close the oven door to the first opening position (approximately 45° angle). Hold the door with one hand on each side and pull it away from the oven at an upwards angle. Put the door with the outer side down on a soft cloth on a stable surface.	

CARE AND CLEANING

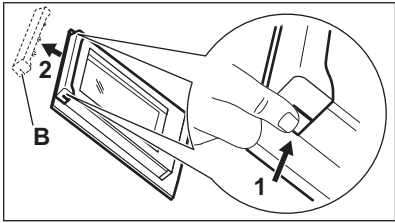
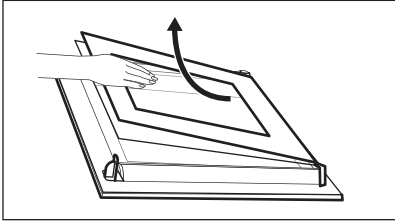
<p>Step 4</p>	<p>Hold the door trim (B) on the top edge of the door at the two sides and push inwards to release the clip seal.</p>	
<p>Step 5</p>	<p>Pull the door trim to the front to remove it.</p>	
<p>Step 6</p>	<p>Hold the door glass panels on their top edge one by one and pull them up out of the guide.</p>	
<p>Step 7</p>	<p>Clean the glass panel with water and soap. Dry the glass panel carefully. Do not clean the glass panels in the dishwasher.</p>	
<p>Step 8</p>	<p>After cleaning, do the above steps in the opposite sequence.</p>	
<p>Step 9</p>	<p>Install the smaller panel first, then the larger and the door. Make sure that the glasses are inserted in the correct position otherwise the surface of the door may overheat.</p>	

11.5 How to replace: Lamp



WARNING!

Risk of electric shock.
The lamp can be hot.

<p>Before you replace the lamp:</p>		
<p>Step 1</p>	<p>Step 2</p>	<p>Step 3</p>
<p>Turn off the oven. Wait until the oven is cold.</p>	<p>Disconnect the oven from the mains.</p>	<p>Put a cloth on the bottom of the cavity.</p>

Back lamp

<p>Step 1</p>	<p>Turn the glass cover to remove it.</p>
<p>Step 2</p>	<p>Clean the glass cover.</p>

Step 3	Replace the lamp with a suitable 300 °C heat-resistant lamp.
Step 4	Install the glass cover.

12. TROUBLESHOOTING



WARNING!

Refer to Safety chapters.

12.1 What to do if...

In any cases not included in this table please contact with an Authorised Service Centre.



The appliance does not turn on or does not heat up

Problem	Check if...
You cannot activate or operate the appliance.	The appliance is correctly connected to an electrical supply.
The appliance does not heat up.	The automatic switch-off is deactivated.
The appliance does not heat up.	The fuse is not blown.
The appliance does not heat up.	The Lock is off.



Components

Problem	Check if...
The lamp is turned off.	Moist Fan Baking - is turned on.
The lamp does not work.	The lamp is burnt out.



Error codes

The display shows...	Check if...
00:00	There was a power cut. Set the time of day.

ENERGY EFFICIENCY



Error codes

If the display shows an error code that is not in this table turn the house fuse off and on to restart the appliance. If the error code recurs contact an Authorised Service Centre.

12.2 Service data

If you cannot find a solution to the problem yourself, contact your dealer or an Authorised Service Centre.

The necessary data for the service centre is on the rating plate. The rating plate is on the front frame of the appliance cavity. Do not remove the rating plate from the appliance cavity.

We recommend that you write the data here:

Model (MOD.)
Product number (PNC)
Serial number (S.N.)

13. ENERGY EFFICIENCY

13.1 Product Information and Product Information Sheet

Supplier's name	Electrolux
Model identification	EDFDC46X 944171776
Energy Efficiency Index	Top oven: 106.8 Main oven: 95.1
Energy efficiency class	Top oven: A Main oven: A
Energy consumption with a standard load, conventional mode	Top oven: 0.78 kWh/cycle Main oven: 0.92 kWh/cycle
Energy consumption with a standard load, fan-forced mode	Top oven: - Main oven: 0.77 kWh/cycle
Number of cavities	2

Heat source	Electricity
Volume	Top oven: 42 l Main oven: 61 l
Type of oven	Built-In Oven
Mass	49.5 kg

IEC/EN 60350-1 - Household electric cooking appliances - Part 1: Ranges, ovens, steam ovens and grills - Methods for measuring performance.

13.2 Energy saving



The appliance has features which help you save energy during everyday cooking.

Make sure that the appliance door is closed when the appliance operates. Do not open the appliance door too often during cooking. Keep the door gasket clean and make sure it is well fixed in its position.

Use metal cookware to improve energy saving.

When possible, do not preheat the appliance before cooking.

Keep breaks between baking as short as possible when you prepare a few dishes at one time.

Cooking with fan

When possible, use the cooking functions with fan to save energy.

Residual heat

The fan and lamp continue to operate. When you turn off the appliance, the display shows the residual heat. You can use that heat to keep the food warm.

When the cooking duration is longer than 30 min, reduce the appliance temperature to minimum 3 - 10 min before the end of cooking. The residual heat inside the appliance will continue to cook.

Use the residual heat to warm up other dishes.

Keep food warm

Choose the lowest possible temperature setting to use residual heat and keep a meal warm.

The residual heat indicator or temperature appears on the display.

Cooking with the lamp off

Turn off the lamp during cooking. Turn it on only when you need it.

Moist Fan Baking

Function designed to save energy during cooking.







When you use this function the lamp is off.



14. MENU STRUCTURE

14.1 Menu

Step 1	Step 2	Step 3	Step 4	Step 5
--------	--------	--------	--------	--------



ENVIRONMENTAL CONCERNS

				
 - select to enter the Menu.	Select the option from Menu structure and press OK .	Select the setting.	OK - press to confirm setting.	Adjust the value and press OK .
Turn the knob for the heating functions to the off position to exit the Menu.				

Menu structure	
Cleaning 	Settings 

Settings					
01	Time of day	Change	02	Display brightness	1 - 5
03	Key tones	1 - Beep 2 - Click 3 - Sound off	04	Buzzer volume	1 - 4
05	Uptimer	On / Off	06	Light	On / Off
07	Fast Heat Up	On / Off	08	Software version	Check
09	Reset all settings	Yes / No			

15. ENVIRONMENTAL CONCERNS

Recycle materials with the symbol . Put the packaging in relevant containers to recycle it. Help protect the environment and human health by recycling waste of electrical and electronic appliances. Do not dispose of appliances marked with the symbol  with the household waste. Return the product to your local recycling facility or contact your municipal office.

www.electrolux.com/shop



867380108-B-382024

